

Smiles

Jenny Dooley - Virginia Evans

Activity Book

1



Express Publishing

Smiles

Activity Book

Contents

Let's Start!	p. 2
Module 1 My Family	p. 4
Module 2 My School	p. 12
Module 3 My Room	p. 20
Module 4 My Pets	p. 28
Module 5 My Food	p. 36
Module 6 My Music	p. 44
Story Cutouts	p. 52

Jenny Dooley – Virginia Evans



Express Publishing



Let's Start!

1 Trace. Draw yourself. Colour. 



NANNY ROSE



LILLY

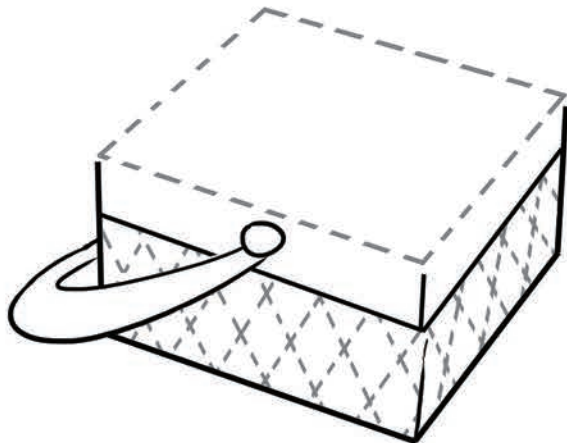
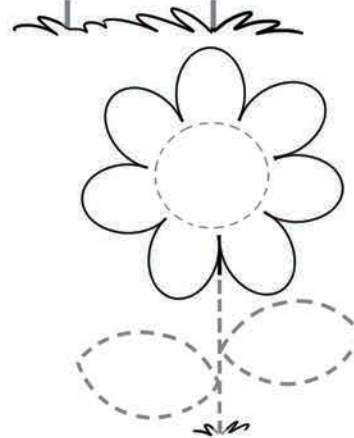
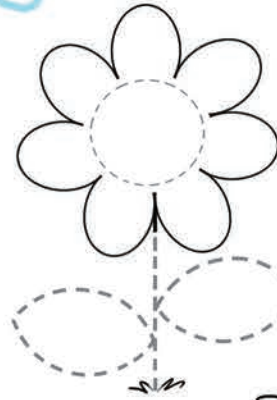

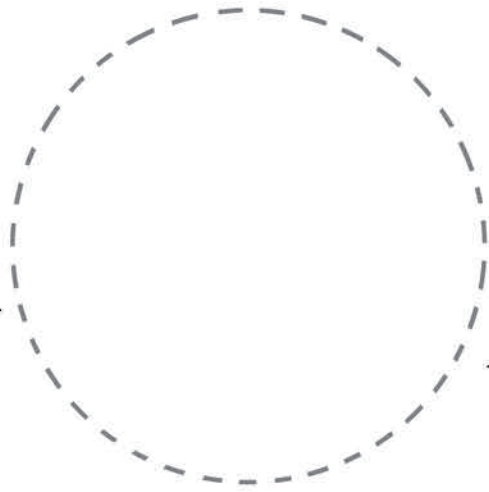

Cover pages 2-3 after page 3 of the Pupil's Book.

1 My Family

1 Match. 

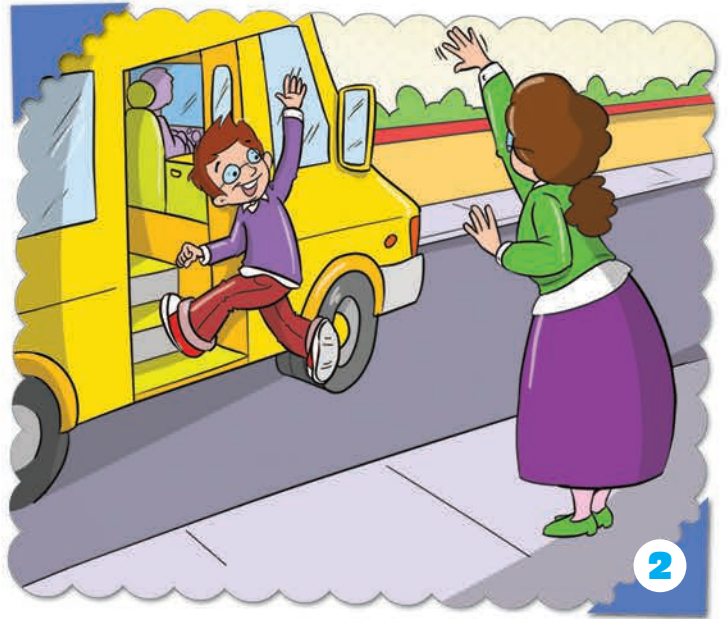

HELLO GOODBYE

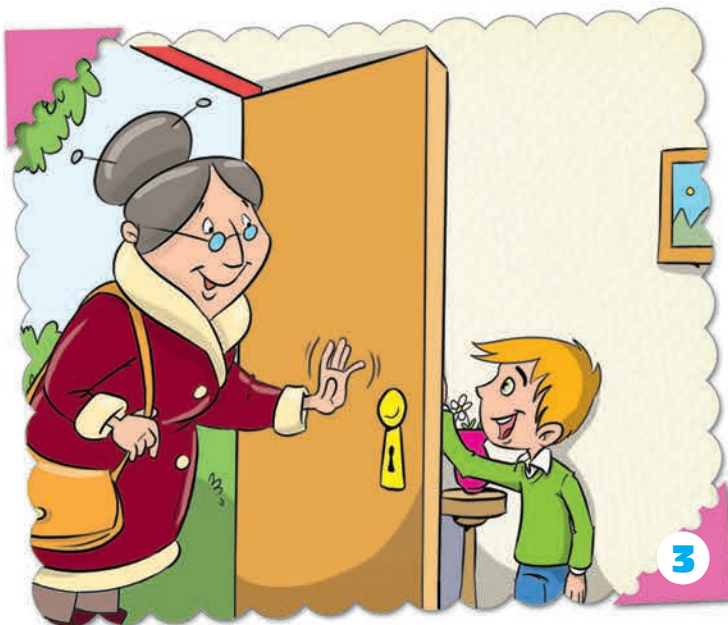

4

Cover this page after page 5 of the Pupil's Book.

2 Trace. Match. 

DADDY MUMMY BROTHER SISTER



3 Look and colour. Then point to and say the colours. 🎨 ✌️ 😊



4 What's next? Find the **Stickers!**  

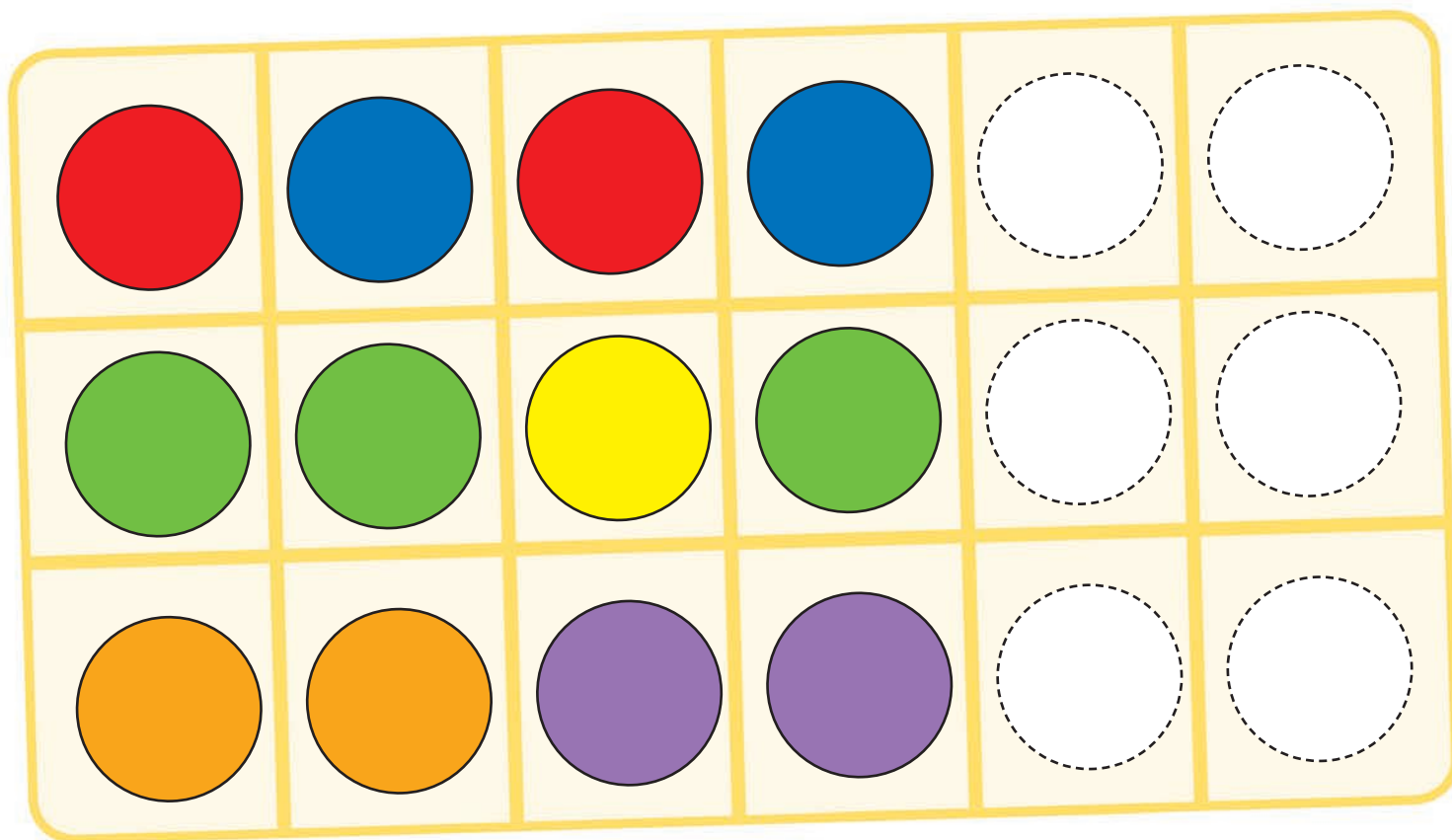

5 Colour. Say.  

My favourite
colour is

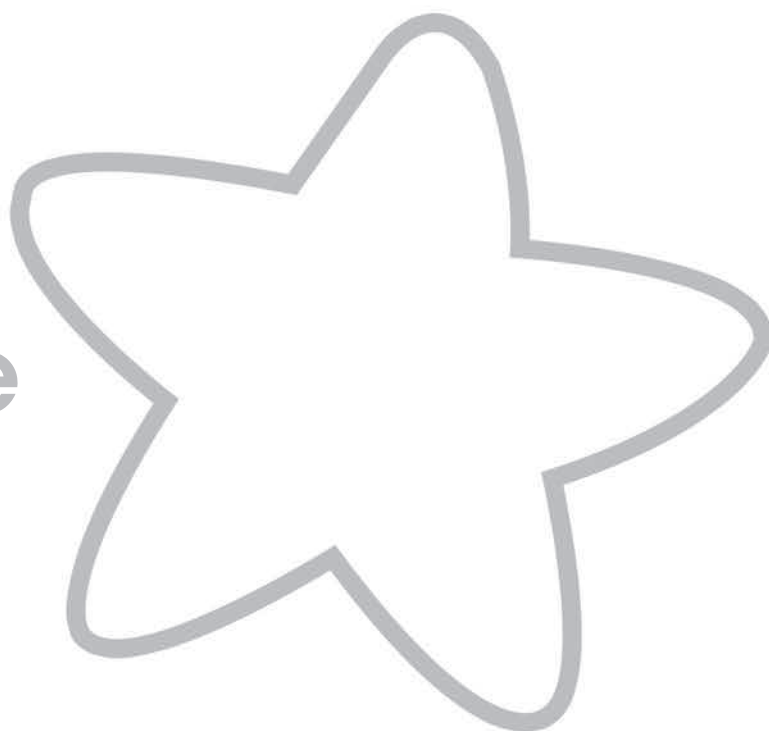



6 Find and colour.  



My progress! 10

Trace. 



Tick (✓). I can ... 



name members of the family.



name colours.



sing the *Hello, Family and Colours* songs.

Board Game 1



5

Oh, no!

6



7



8

Great!

4



3



2



1

START



= Go back to Start!



= Play again!

Great!

9



10

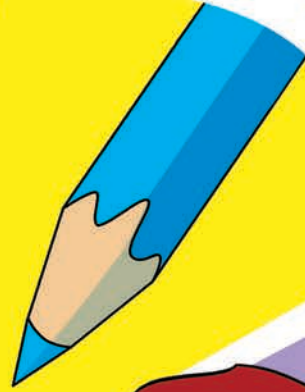

11



12

Oh, no!

13

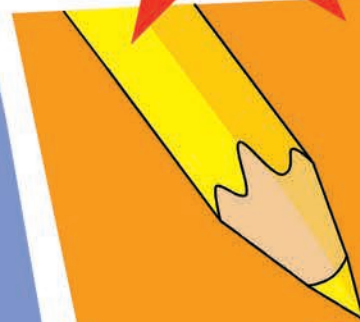

14

Oh, no!

15

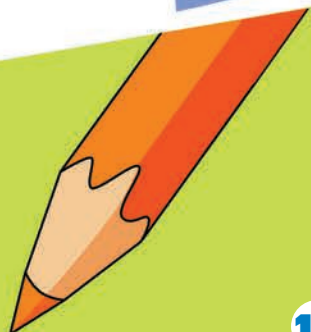

16

FINISH



2 My School

1 Join, find and trace.  



2 Colour. Then count and write. 

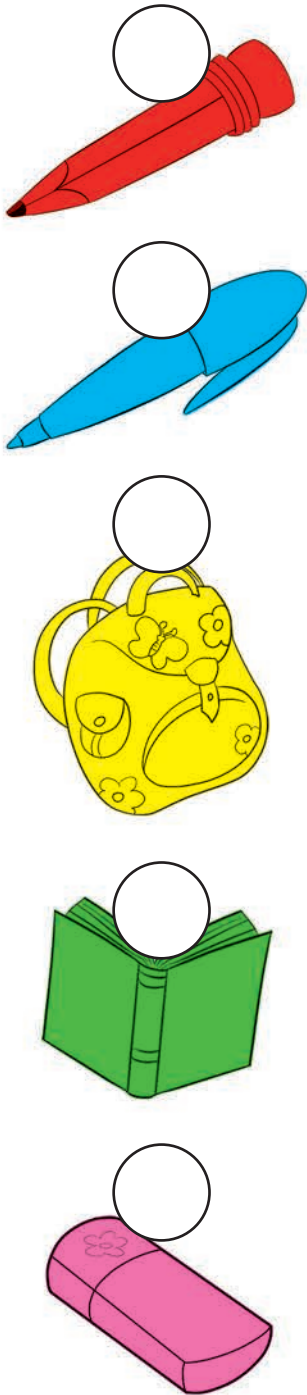

Cover this page after page 21 of the Pupil's Book.



3 How many? Count and write. Then colour and say.   

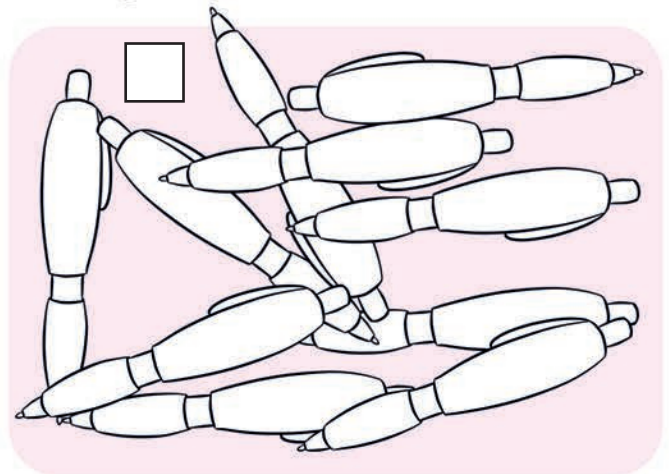
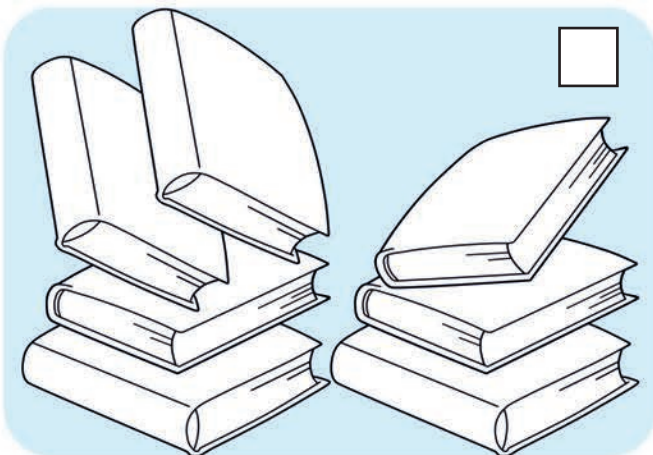
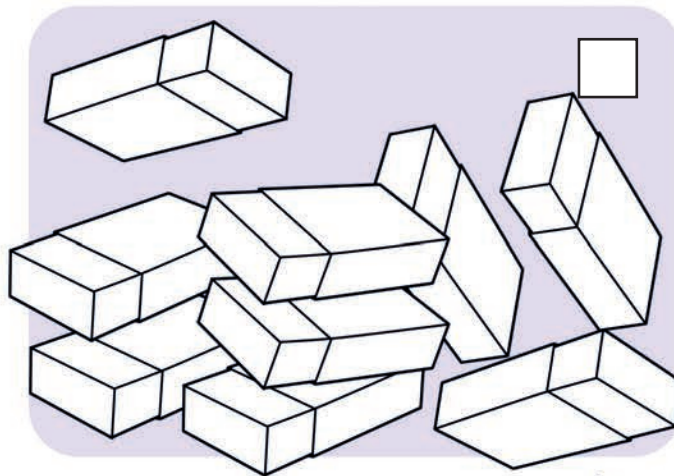
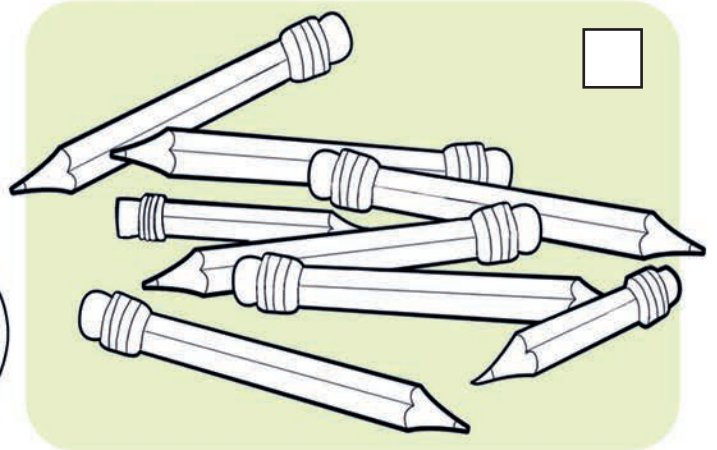
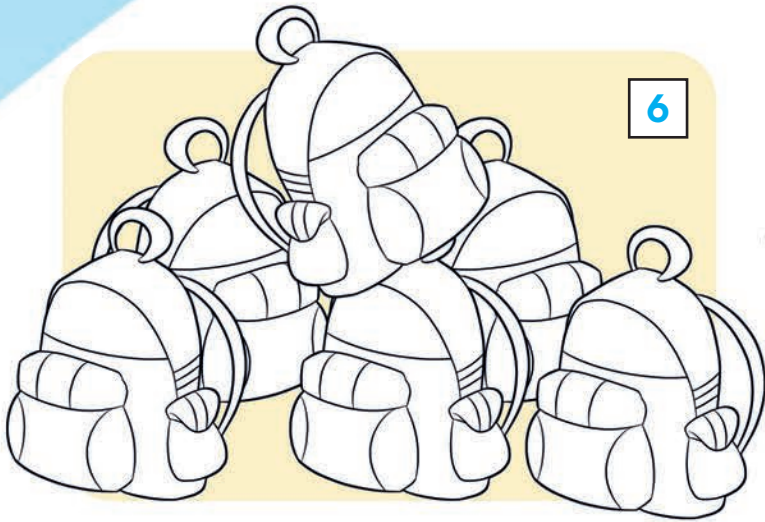

4 Find the **Stickers**! Then match.   

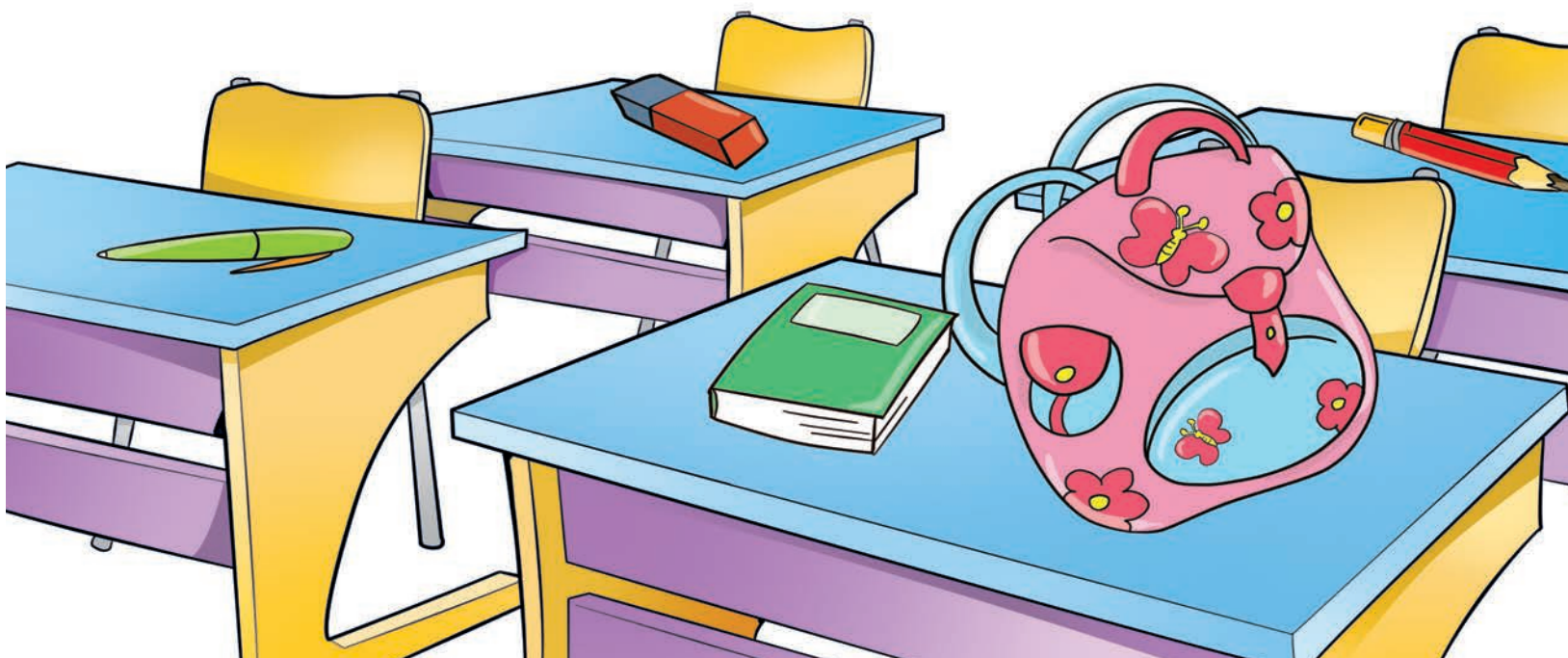
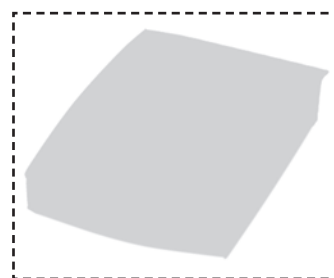
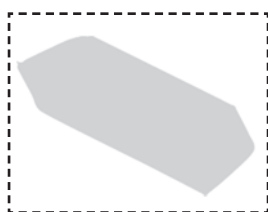
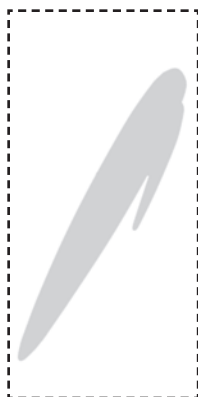



Storytime

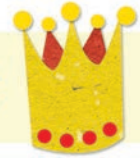

5 Put the story in order. Number the pictures. 

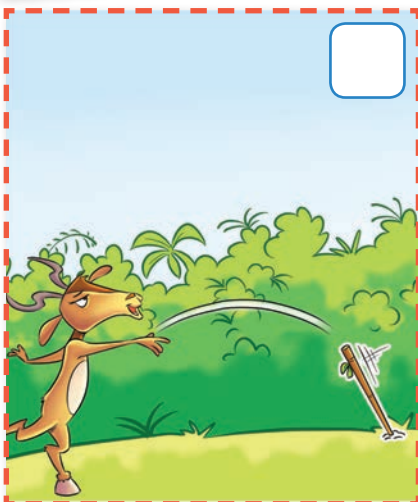
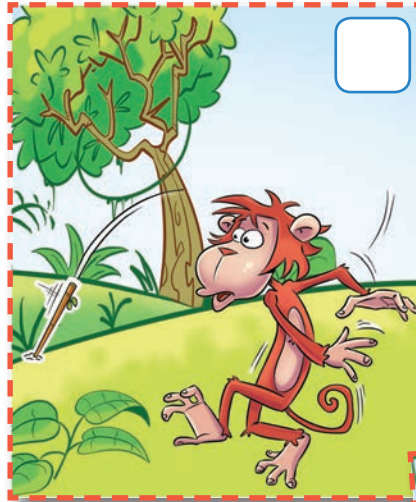

THE END

Trace. 



1 one 2 two 3 three 4 four 5 five
6 six 7 seven 8 eight 9 nine 10 ten



schoolbag



book



pen



rubber

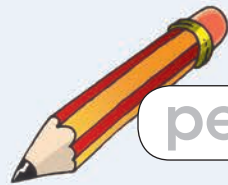

pencil

Tick (✓). I can ... 



count from 1 to 10.



name school items.



sing the Numbers, Get your pencil and Pencils in my schoolbag songs.

Board Game 2



6



7

8



4



3



2



1



START



= Go back to Start!



= Play again!



9

9

10

Great!

11

10

12

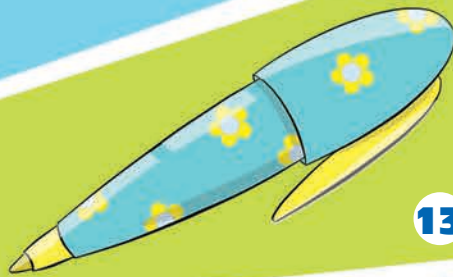

13

8

14



15



FINISH

18

Oh, no!

2

17

5

16

19

3 My Room

1 What are they? Colour and say. 🎨 😊

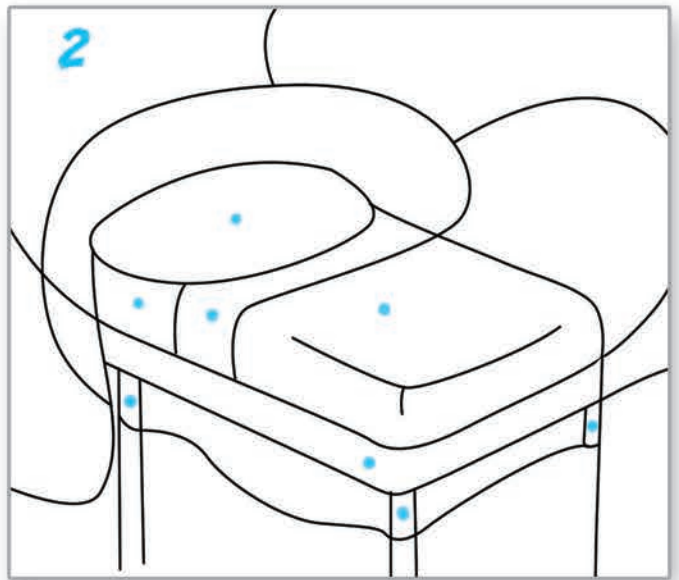
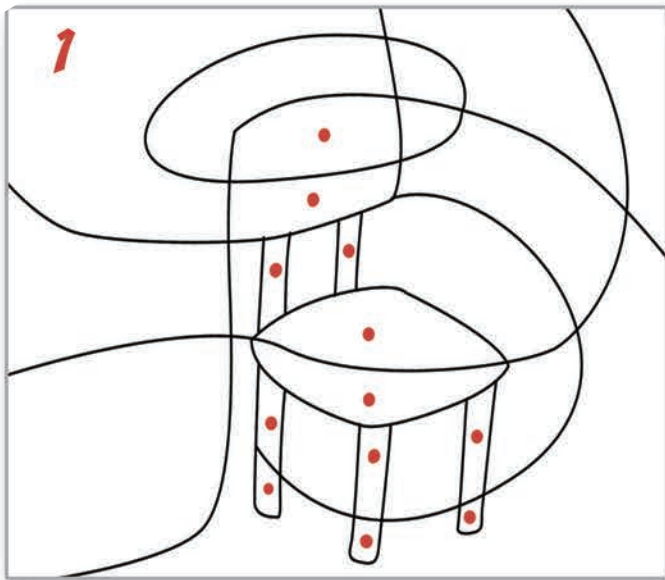

2 Trace. Circle. 

1



A RED BIKE



2

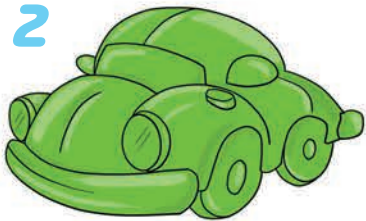

A GREEN CAR

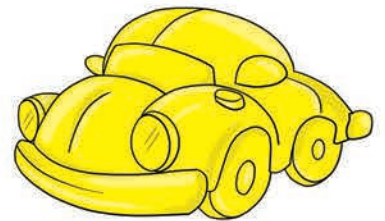

3

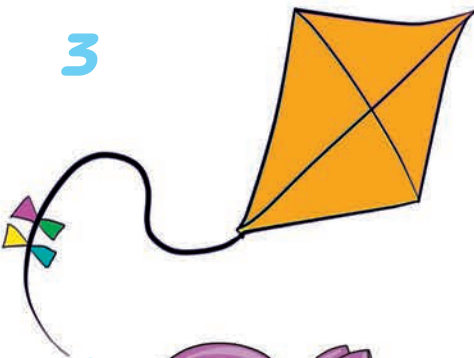

A BLUE KITE

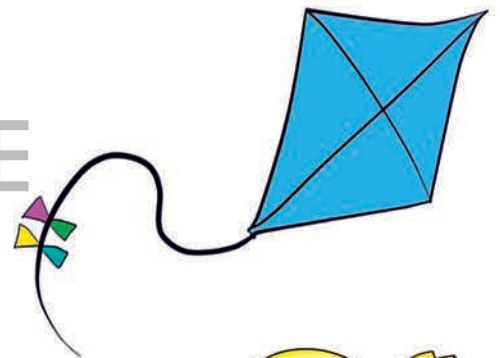

4



A YELLOW DOLL



5

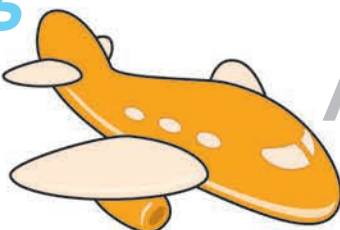

A PURPLE PLANE

